

PAIR OF PROFILE KNIVES HEIGHT 40MM NR. 0096

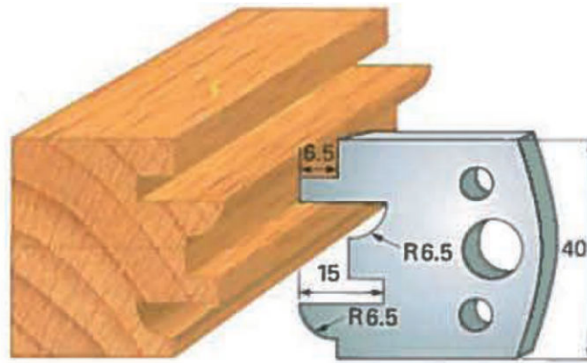

Art. SA0096 - (SA1096)

Klein
S I S T E M I

€16,53 (excl. VAT)

Set of profile knives of height 40mm Nr. 0096 suited for universal moulding blocks. Used for moulding of wood at low costs. The steel alloy with 16% cobalt guarantees a high quality cut and a comfortable cutting process.

SKU: KL-SA0096

GALERIJAFBEELDINGEN



Set of profile knives of height 40mm Nr. 0096 suited for universal moulding blocks. Used for moulding of wood at low costs. The steel alloy with 16% cobalt guarantees a high quality cut and a comfortable cutting process.

PRODUCT INFORMATION

- High quality cutting
 - Height 40mm
- Comfortable moulding
- Steel alloy with 16% cobalt

DESCRIPTION

Set of profile knives of height 40mm Nr. 0096 suited for universal moulding blocks. Used for moulding of wood at low costs. The steel alloy with 16% cobalt guarantees a high quality cut and a comfortable cutting process.

No video available for this product!

DOWNLOADS

No download available.

ADDITIONAL INFORMATION

Weight 0,05 kg

Dimensions 0,4 cm