

PLUG CUTTER Ø8MM WITH SHANK 13MM

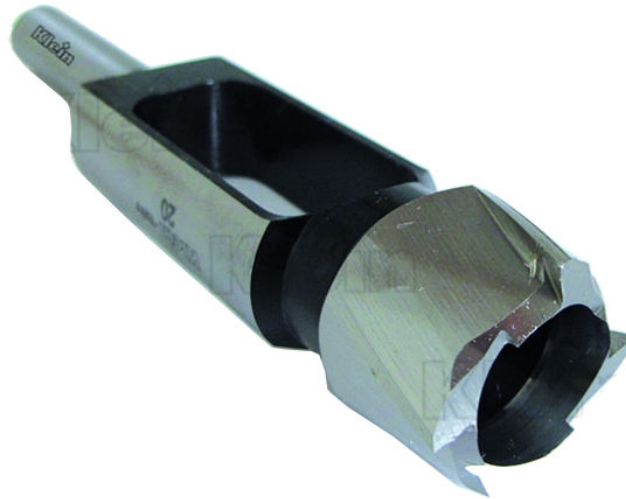

€84,00 (excl. VAT)

Plug cutters to be used on all wood types. These straight wood plug cutters are used to make plugs to be inserted after having drilled with "Forstner" bits. Use the plugs after installing sunken screws and sand the top of the plug flush with the wood surface to create nearly invisible screw connections on your wood projects. This cutter has a length of 140mm and 4 SP cutting teeth.

SKU: KL-R220080R

GALERIJAFBEELDINGEN

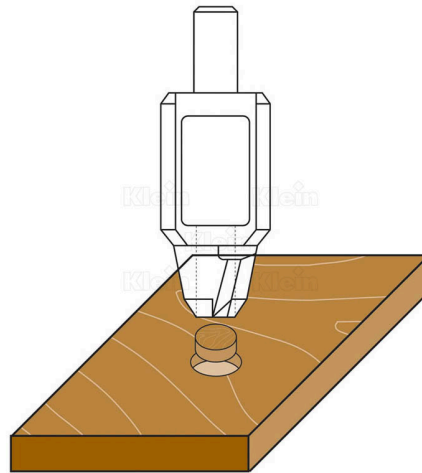
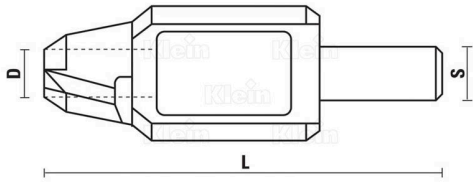

Plug cutters to be used on all wood types. These straight wood plug cutters are used to make plugs to be inserted after having drilled with "Forstner" bits. Use the plugs after installing sunken screws and sand the top of the plug flush with the wood surface to create nearly invisible screw connections on your wood projects. This cutter has a length of 140mm and 4 SP cutting teeth.

PRODUCT INFORMATION

- To be used with all wood types.
- Create invisible screw connections
 - SP teeth

DESCRIPTION

Plug cutters to be used on all wood types. These straight wood plug cutters are used to make plugs to be inserted after having drilled with "Forstner" bits. Use the plugs after installing sunken screws and sand the top of the plug flush with the wood surface to create nearly invisible screw connections on your wood projects. This cutter has a length of 140mm and 4 SP cutting teeth.

No video available for this product!

DOWNLOADS

No download available.

ADDITIONAL INFORMATION

Weight	0,05 kg
diameter	8mm
Length	140mm
Shank	13x50mm
Number of teeth	4