

QUATRO SAW BLADE FOR HARD MATERIALS Ø160MM - BORE 20MM



€54,00 (excl. VAT)

Saw blade with 30 teeth

Saw blade 'Quatro' with special form of teeth, suited for cutting of ferro & non-ferro metal, aluminium, hardwood and other hard materials. For hand saws, mitre-saws and table saws. This saw blade delivers a precise and clean cut.

SKU: KL-LZ16003020

GALERIJAFBEELDINGEN

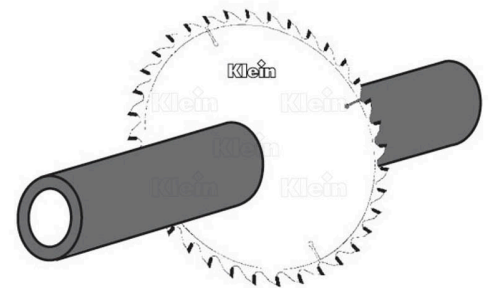
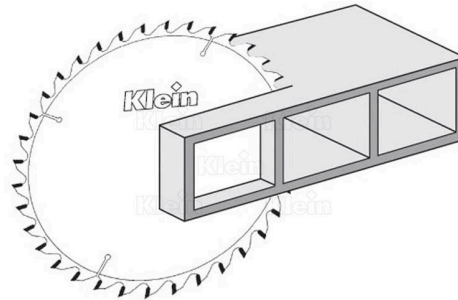
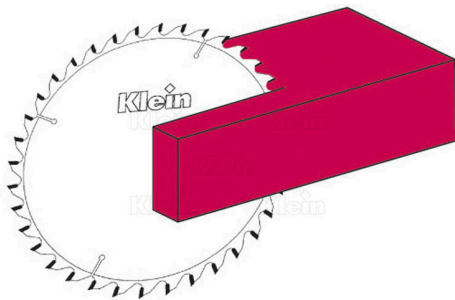
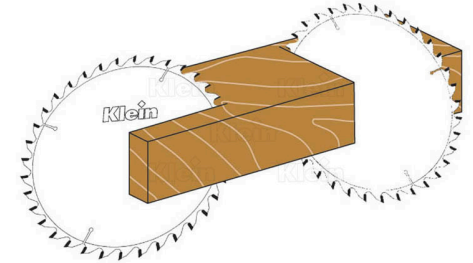
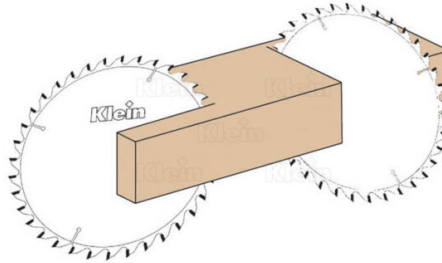
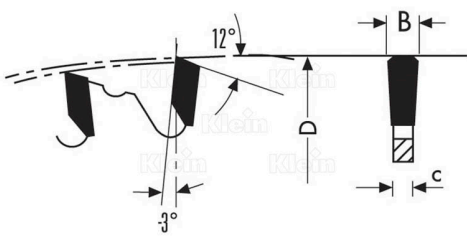

Saw blade with 30 teeth

Saw blade 'Quatro' with special form of teeth, suited for cutting of ferro & non-ferro metal, aluminium, hardwood and other hard materials. For hand saws, mitre-saws and table saws. This saw blade delivers a precise and clean cut. Make sure to use the right amount of teeth to achieve optimal results of your project. A low number of teeth is suited for fast-paced and rough sawing. A high number of teeth calls for a lower operating speed but guarantees a clean cut.

PRODUCT INFORMATION

- Fine cut HW saw blade
- TR special form of teeth
- 3° negative hook angle
 - For hard materials
- For hand saws, mitre-saws and table saws.

DESCRIPTION

Saw blade with 30 teeth Saw blade 'Quatro' with special form of teeth, suited for cutting of ferro & non-ferro metal, aluminium, hardwood and other hard materials. For hand saws, mitre-saws and table saws. This saw blade delivers a precise and clean cut. Make sure to use the right amount of teeth to achieve optimal results of your project. A low number of teeth is suited for fast-paced and rough sawing. A high number of teeth calls for a lower operating speed but guarantees a clean cut.

No video available for this product!

DOWNLOADS

No download available.

ADDITIONAL INFORMATION

Weight	1 kg
Diameter sawblade	160mm
Shaft diameter	20mm
Thickness teeth	2,2mm
Thickness Sawblade	1,6mm
Number of teeth	30