

REDUCTION RING FOR SAWBLADES Ø20/16MM



€4,80 (excl. VAT)

Adapter ring to reduce the bore of your saw blade to comply with your machine. Make sure every saw blade is compatible with your own machine thanks to these convenient reduction rings.

Reduction from bore 20mm to 16mm.

SKU: KL-ZA00002016

GALERIJAFBEELDINGEN

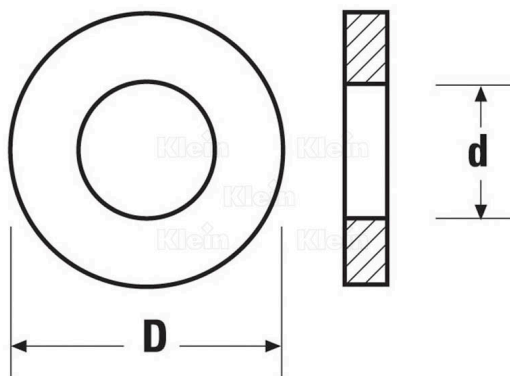

Adapter ring to reduce the bore of your saw blade to comply with your machine. Make sure every saw blade is compatible with your own machine thanks to these convenient reduction rings.

Reduction from bore 20mm to 16mm.

PRODUCT INFORMATION

- Reduction ring for sawblades

DESCRIPTION

Adapter ring to reduce the bore of your saw blade to comply with your machine. Make sure every saw blade is compatible with your own machine thanks to these convenient reduction rings. **Reduction from bore 20mm to 16mm.**

No video available for this product!

DOWNLOADS

No download available.

ADDITIONAL INFORMATION

Weight	0,05 kg
diameter	20mm
Shaft diameter	16mm