

## REDUCTION RING FOR SAWBLADES Ø30/25MM



**€4,80 (excl. VAT)**

Adapter ring to reduce the bore of your saw blade to comply with your machine. Make sure every saw blade is compatible with your own machine thanks to these convenient reduction rings.

**Reduction from bore 30mm to 25mm.**

**SKU:** KL-ZA00003025

**GALERIJAFBEELDINGEN**

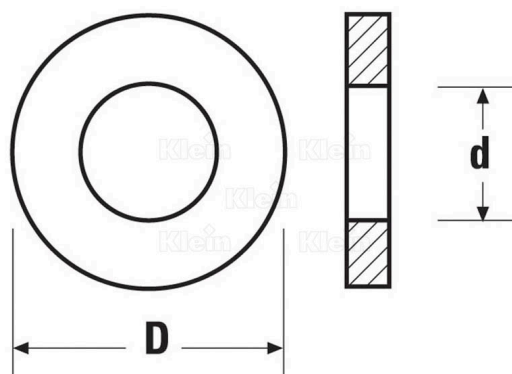

Adapter ring to reduce the bore of your saw blade to comply with your machine. Make sure every saw blade is compatible with your own machine thanks to these convenient reduction rings.

**Reduction from bore 30mm to 25mm.**

### PRODUCT INFORMATION

- Reduction ring for sawblades

### DESCRIPTION

Adapter ring to reduce the bore of your saw blade to comply with your machine. Make sure every saw blade is compatible with your own machine thanks to these convenient reduction rings. **Reduction from bore 30mm to 25mm.**

No video available for this product!

### DOWNLOADS

No download available.

### ADDITIONAL INFORMATION

<b>Weight</b>	0,05 kg
<b>diameter</b>	30mm
<b>Shaft diameter</b>	25mm