

REDUCTION RING FOR SAWBLADES Ø35/30MM



€4,80 (excl. VAT)

Adapter ring to reduce the bore of your saw blade to comply with your machine. Make sure every saw blade is compatible with your own machine thanks to these convenient reduction rings.

Reduction from bore 35mm to 30mm.

SKU: KL-ZA00003530

GALERIJAFBEELDINGEN

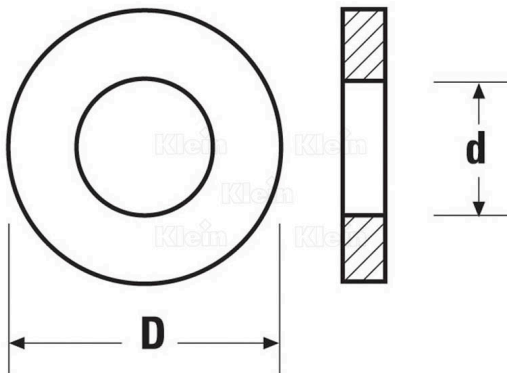

Adapter ring to reduce the bore of your saw blade to comply with your machine. Make sure every saw blade is compatible with your own machine thanks to these convenient reduction rings.

Reduction from bore 35mm to 30mm.

PRODUCT INFORMATION

- Reduction ring for sawblades

DESCRIPTION

Adapter ring to reduce the bore of your saw blade to comply with your machine. Make sure every saw blade is compatible with your own machine thanks to these convenient reduction rings. **Reduction from bore 35mm to 30mm.**

No video available for this product!

DOWNLOADS

No download available.

ADDITIONAL INFORMATION

Weight	0,05 kg
diameter	35mm
Shaft diameter	30 mm