

REDUCTION RING FOR SAWBLADES Ø40/30MM



€4,80 (excl. VAT)

Adapter ring to reduce the bore of your saw blade to comply with your machine. Make sure every saw blade is compatible with your own machine thanks to these convenient reduction rings.

Reduction from bore 40mm to 30mm.

SKU: KL-ZA00004030

GALERIJAFBEELDINGEN

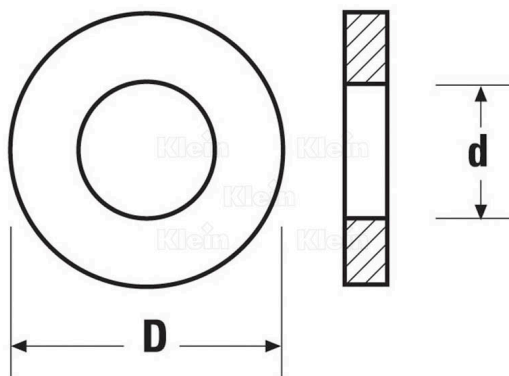

Adapter ring to reduce the bore of your saw blade to comply with your machine. Make sure every saw blade is compatible with your own machine thanks to these convenient reduction rings.

Reduction from bore 40mm to 30mm.

PRODUCT INFORMATION

- Reduction ring for sawblades

DESCRIPTION

Adapter ring to reduce the bore of your saw blade to comply with your machine. Make sure every saw blade is compatible with your own machine thanks to these convenient reduction rings. **Reduction from bore 40mm to 30mm.**

No video available for this product!

DOWNLOADS

No download available.

ADDITIONAL INFORMATION

Weight	0,05 kg
diameter	40mm
Shaft diameter	30 mm