

SAW BLADE FOR CONSTRUCTION Ø400MM - BORE 30MM



€117,00 (excl. VAT)

Saw blade with 28 teeth

Construction saw blade with 'flat angle' teeth and a wide back for improved support of the tooth. With few teeth for a rough and fast cut of the wood. Equipped with teeth in high quality carbide (widia). Suitable for use on pallet wood or wood with remnants of nails,... Thanks to the wide back, the teeth are less likely to be damaged if you hit nails or other debris in the wood during sawing. Ideal for construction site saws or tilting log saws. Made in Germany, take advantage of the extremely solid German quality.

SKU: 3ZBBH4003028HMN

GALERIJAFBEELDINGEN

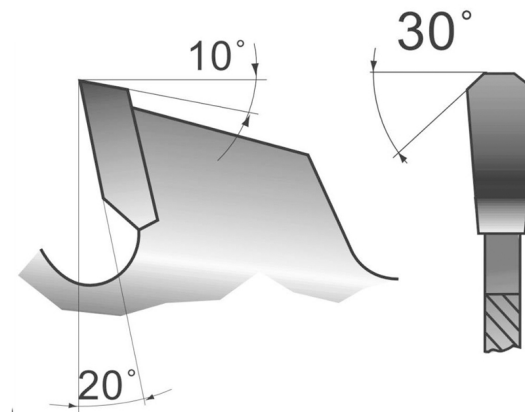

Saw blade with 28 teeth

Construction saw blade with 'flat angle' teeth and a wide back for improved support of the tooth. With few teeth for a rough and fast cut of the wood. Equipped with teeth in high quality carbide (widia). Suitable for use on pallet wood or wood with remnants of nails,... Thanks to the wide back, the teeth are less likely to be damaged if you hit nails or other debris in the wood during sawing. Ideal for construction site saws or tilting log saws.

Made in Germany, take advantage of the extremely solid German quality.

PRODUCT INFORMATION

- Teeth in high quality carbide (widia)
- Made in Germany - German high quality
 - For firewood tilting log saws
 - Different types of wood
 - Construction wood, palettes,...
 - 'Flat angle' tooth
 - Wide back for support

DESCRIPTION

Saw blade with 28 teeth Construction saw blade with 'flat angle' teeth and a wide back for improved support of the tooth. With few teeth for a rough and fast cut of the wood. Equipped with teeth in high quality carbide (widia). Suitable for use on pallet wood or wood with remnants of nails,... Thanks to the wide back, the teeth are less likely to be damaged if you hit nails or other debris in the wood during sawing. Ideal for construction site saws or tilting log saws. Made in Germany, take advantage of the extremely solid German quality.

No video available for this product!

DOWNLOADS

No download available.

ADDITIONAL INFORMATION

Weight	1 kg
Diameter sawblade	400mm
Shaft diameter	30 mm
Thickness teeth	3,8mm
Number of teeth	28